

3G GPS Vehicle Tracker

(GPS+WCDMA+SMS)

User Manual

(Version 1.3)



This user manual has been specially designed to guide you through the functions and features of your GPS vehicle tracker.

1.Start Guide

1.1 Accessories

- ◆ Main device
- ◆ Power cord
- ◆ 4-pin relay
- ◆ 5-pin relay*2
- ◆ Microphone
- ◆ SOS cable
- ◆ Extension cable
- ◆ User manual

1.2 Main Functions

- ◆ Real-time GPS+AGPS tracking
- ◆ Track by time interval/distance/direction change
- ◆ Track through SMS, APP, Web
- ◆ Remotely fuel/power cut-off control
- ◆ Voice monitor
- ◆ SOS alarm
- ◆ Geo-fence alarm
- ◆ Vibration alarm
- ◆ Movement alarm
- ◆ External power supply cut-off alarm
- ◆ Door status-detection
- ◆ Analog & Digital input/Digital output
- ◆ Find the car by triggering light and buzzer
- ◆ Over-the Air (OTA)
- ◆ Low battery alert

1.3 Specifications

Frequency	WCDMA 850/900/1900/2100MHz GSM 850/900/1800/1900MHz
Networks	WCDMA /EDGE/GPRS
Operating Voltage	9-36VDC<300mA
Location Time	Cold Start: <35s Hot Start : <2s
Location Accuracy	<10 meters
Operating Temperature	-20°C ~ +70°C
Dimension	98.5(L) x 52(W) x 15(H) mm
Weight	80g

2. My device

2.1 Appearance

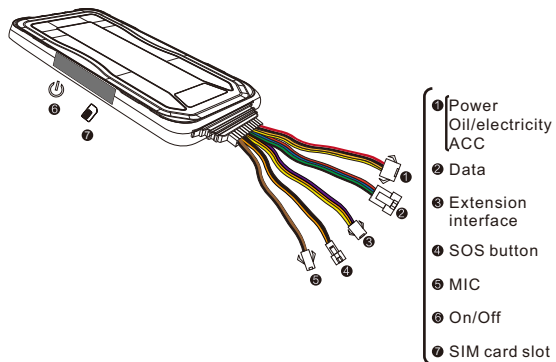

2.2 LED indicators

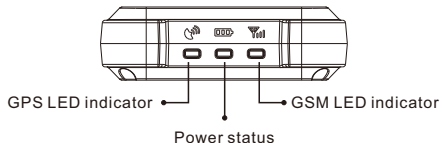

GPS LED Indicator - Blue		
● - ○	0.1s ON & 0.1s OFF	Searching GPS signal
●	Steady on	GPS is fixed
○	OFF	No GPS fixed or initializing

GSM LED Indicator - Green		
● - ○	0.1s ON & 0.1s OFF	GSM initializing
● - ○○	0.1s ON & 1.9s OFF	Receive GSM signal normally
●	Steady on	Connected to GPRS network
○	OFF	No GSM signal

Power Status - Red		
● - ○	0.1s ON & 0.1s OFF	Low battery
●● - ○○	2s ON & 2s OFF	Full charged
● - ○○	0.1s ON & 1.9s OFF	Normal operating
●	Steady on	Device is charging
○	OFF	Low battery/Power off

● - ● - ●	Flash in a loop	Device is in defense status
-----------	-----------------	-----------------------------

3. Installation

3.1 Install the SIM card

Notice

SIM should be inserted correctly.

SIM card should have GPRS service.

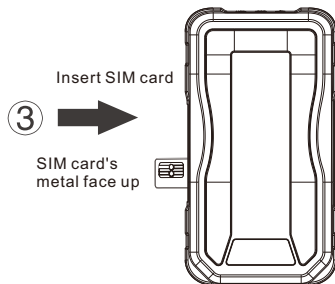
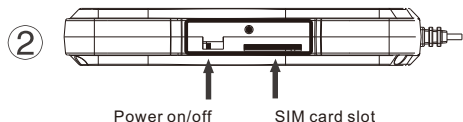
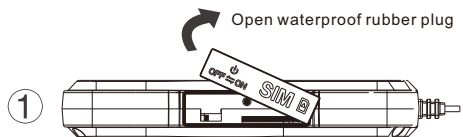

3.2 Device Wire Definition

Picture 1

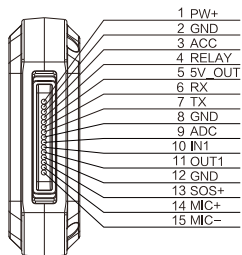
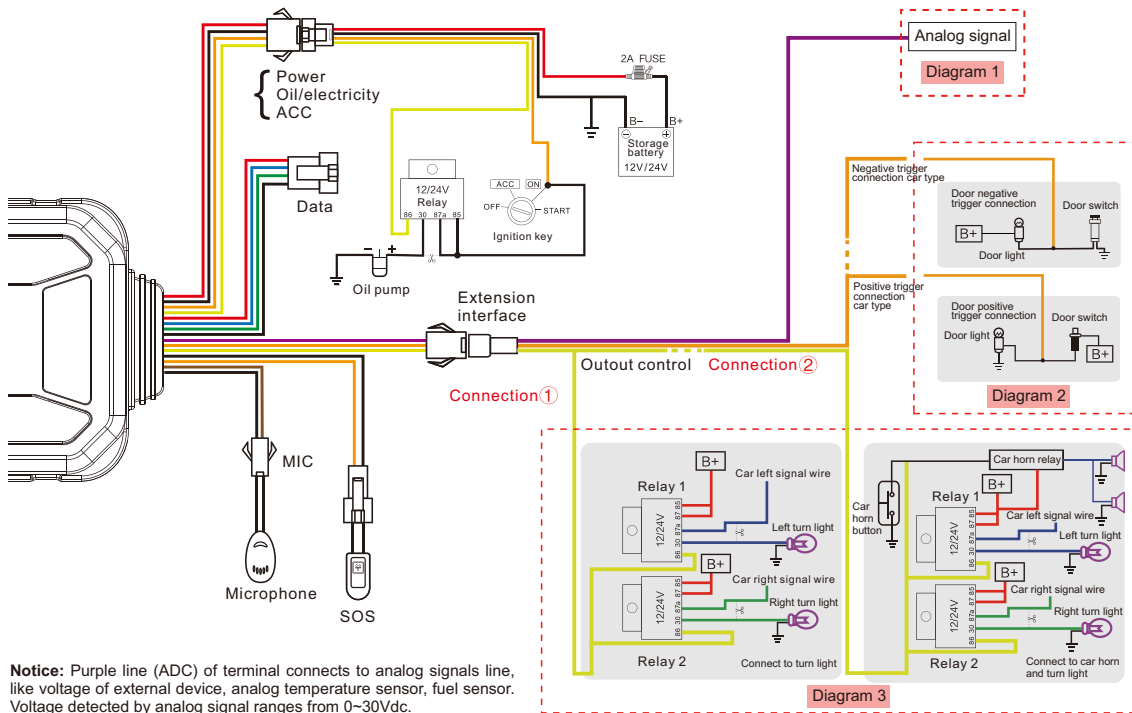

Table 1

Line	Color	Description	Definition
1	Red	PW+	12V/24V car battery positive
2	Black	GND	12V/24V car battery negative
3	Orange	ACC	ACC ignition
4	Yellow	RELAY	Relay
5	Red	5V-OUT	External power supply
6	Blue	RX	Data receiving / backup interface
7	Green	TX	Data sending/ backup interface
8	Black	GND	Ground(Negative electrode)
9	Purple	ADC	Extended Interface
10	Orange	In1	
11	Yellow	OUT1	SOS button
12	Black	GND	
13	Orange	SOS+	
14	Brown	MIC+	Microphone
15	Black	MIC-	

3.3 Device Wiring Way



Notice: Purple line (ADC) of terminal connects to analog signals line, like voltage of external device, analog temperature sensor, fuel sensor. Voltage detected by analog signal ranges from 0~30Vdc.

Wiring Instruction

- 1.The standard power supply ranges from 9V to 36VDC. Please use the power cord manufactured by the original factory. Red line means positive side while black line means negative side. During installation, negative side should connect to the ground, do not connect with other ground wires at the same time.
- 2.ACC line (orange) connects to vehicle's ACC switch, detecting ignition on and off.
- 3.Device's oil and electricity control line (yellow) connects to relay's 86. (thin yellow line of relay socket)

Relay wiring instruction

Relay wiring way of oil pump open circuit: On each end of the wire is thin white line (85) and thin yellow line (86). Thin white line (85) connects to the positive side of battery (12V) while thin yellow line (86) connects to the device relay control. There is an oil pump in the vehicle. Cut off the positive line. The positive side of oil pump connects to the close-end of relay.(Thick green line 87a), and the other side connects to relay's common(green thick 30).

Notice

12V relay is standard. The device is suitable for vehicles with 12V battery. If the vehicle has 24V battery, then 24V relay is needed.

- 4.To monitor analog signals, the purple line (ADC) of extended port should be connected to the analog line.
- 5.To check status of car door, orange line (IN1) should be connected to where between the door light and door switch (See the diagram).
- 6.To find car remotely, please connect the yellow line (OUT1) of extended port to external relay.

Wiring instruction for remote trigger car light and buzzer

Thin white line (85) and thick green line (87) of relay should be connected to car battery's positive pole. The thin yellow line (86) is connected to the yellow line (OUT1) of extended port. Cut off the line of car turn light first and then connect one side with turn light to the common terminal (thick green line 30) and other side to closed terminal (thick green line 87a). See diagram for wiring way.

3.4 Device Installation

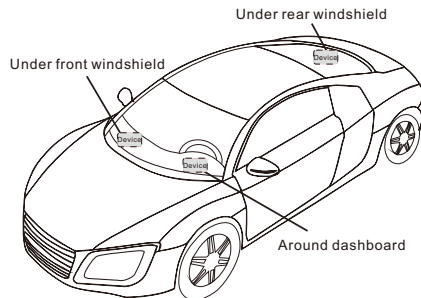

Note :

The device should face up to the sky.

Metal thermal barrier or heating layer of the windshield affects the signal. Please change installation places to receive better signal.

4. Operation of device

Power on/ Power off

Power on: Once you insert a valid SIM card and connect all the wires, turn on the device. Power LED will flash first. During signal searching process, GSM LED and GPS(blue) LED will flash. Once Blue GPS LED keeps steadily ON, it means the device has been located and it starts to work.

Power off: Just turn off the power switch.

Notice:

When device is connected with external power, please turn on the battery switch. The battery will then connect with the device circuits and its built-in battery will be charged. If battery is OFF, battery can't be charged. The device will be power off if no external power supply.

5. Main Functions

5.1 SOS

In emergent case, press SOS for 3 seconds to activate SOS alarm. Then the device will send SOS SMS to preset SOS numbers and then dial the numbers in a loop for 3 times until the call is picked up. Alarm message will also send to platform. (See command list 7-8)

5.2 Power cut-off alarm

When the electricity supply of device is cut off, it will activate cut-off alarm.

5.3 Low battery alarm

When battery is low, the device will activate low battery alarm.

5.4 Vibration alarm(default OFF)

When vehicle vibrates several times, the vibration alarm will be triggered. If no ignition after 3 minutes (ACC OFF), the device will send vibration alarm message immediately.
(See command list 7-12)

5.5 Voice monitoring

Use pre-set SOS number to dial the device, after 10 seconds, device changes to monitoring mode automatically. The caller can then hear the noise inside the vehicle. Device won't be in monitor mode when non-SOS number call in.

Notice

- 1.Pre-set SOS number is necessary.
- 2.SIM card of device must have caller ID service.

5.6 Displacement alarm(default OFF)

Device will send movement alarm when vehicle moves out the pre-set distance (when ACC is off and GPS is fixed).

5.7 Oil/Electricity cut-off

When vehicle is stolen, oil/electricity cut-off command can be sent by platform, APP or SMS.

Notice

1. Make sure ACC is correctly connected.
2. When ACC is OFF, command will be executed immediately.
3. When ACC is ON, but GPS is not fixed, command will be postponed.
4. When ACC is ON, GPS is fixed, command will be executed when vehicle speed is less than 20km/h.

If you want to cut off/restore oil by SMS command, you have to set a center number firstly. Only the center number can send the cut off/restore oil command to the device. (See command list 7-14)

Notice

1. Only the SOS number can be used to set center number.
2. Only the SOS number can be used to delete center number.
3. There is only one center number can be set.

5.8 Restore oil/electricity

When alarm is all-clear, you can send restore oil/electricity command by platform, APP or SMS and restore vehicle power. (See command list 7-15)

5.9 Restart device

If GPRS is abnormal (device is offline), you can send SMS command **RESET#** to restart the device. Device will reboot after 20 seconds after receiving the command. (See command list 7-16)

5.10 Door detection

The device is able to detect door status. It uploads car status to platform and APP timely. Negative triggering is default. When car door's status is negative triggering, there is no need to set. Instead, if car door status is positive triggering, the triggering way has to be modified. (Command: DOOR,1#). See diagram 2 (3.3) for wiring way. (See command list 7-17)

Notice

Negative triggering (default): when door is open, signal level of door is 0V; when door is closed, signal level of door is power voltage. Positive triggering: when door is open, signal level of door is power voltage; when door is closed, signal level of door is 0V.

5.11 Analog signal

The device can measure car battery's voltage and upload it to platform/APP in fixed time based on your needs. Purple line (ADC) of device extended port can receive analog signal, like voltage of external device, analog temperature sensor and fuel sensor. Voltage range of analog input is 0~30Vdc. See diagram (3.3) for wiring way. (See command list 7-18)

5.12 Find the car by triggering light and buzzer

When need to pick out the car parking on giant parking lot, you can send a command. After the device receives the command, it will control turn light relay or horn relay by the yellow line of extended port, so as to trigger the car's light or horn. In this way, you can figure out your car's position easily and accurately. See diagram 3(3.3) for wiring way. (See command list 7-19)

6. Platform Operation

Get registered on the designated service platform by authorized dealer, then you can start the tracking service and settings.

6.1 APN & Server setting

To ensure normal network operation, please confirm your APN and server setting before login.

In most countries, APN could be automatically adapted to local mobile operators. If not, please send SMS to set the APN.

If username and password is required for APN, please add it into the command. (See command list 7-6)

Confirm the server address and setting with distributors. If server is incorrect, please send SMS to change.

SERVER,mode,domainName/IP,port,0#

E.g. SERVER,1,www.ydpat.com,8011,0#

SERVER,0,211.154.135.113,8011,0#

mode = 1 means set with domain name

mode = 0 means set with ip address

6.2 Login service platform

Please login the designated service platform to set and operate the device.

6.3 Download APP

Please download and install the APP in designated website, APP store or Google Play store.

7.Common Command List

Edit SMS command in the right column to the device SIM number to achieve respective function as below:

1	Device status	STATUS#
2	Device coordinate	WHERE#
3	Location URL	URL#
4	Check version	VERSION#
5	Network setting	GPRSSET#
6	APN setting	1. APN, [apnname]# E.g: APN,internet# 2. APN, [apnname],[user],[pwd]# E.g: APN,internet,CLIENTE,AMENA#
7	Server setting	SERVER,mode,domain/IP,port,0# E.g. SERVER,1,www.ydpat.com,8011,0# SERVER,0,211.154.135.113,8011,0# mode1 means set with domain name mode 0 means set with ip address
8	SOS setting	1. Add SOS number: SOS,A,number 1,number 2,number 3# 2.Delete subjected sequence of SOS number: SOS,D,number sequence 1, number sequence 2, number sequence 3# E.g. SOS,D,1,2,3# 3. Delete the SOS number : SOS,D,phone number# 4. Query SOS number : SOS#
9	GPS data upload time interval	TIMER,T1,T2# T1=5~18000 seconds ; ACC ON upload interval ; default value : 10 T2=5~18000 seconds ; ACC OFF upload interval ; default value : 10 (when GPS is not sleep)

10	GPS data upload distance interval	DISTANCE,D# D=0. 50~10000 meter ; Distance interval ; default value : 300, unit : meter ;
11	Delayed defense setting	DEFENSE,A# A:1~60 minutes. set delayed defense, default value : 10 minutes
12	Vibration alarm (default OFF)	1. SENALM,ON# 2. SENALM,OFF#
13	Displacement alarm setting (default OFF)	1. MOVING,ON,R,M# R=100~1000; Displacement radius, unit: meter M=0-2; Alert way 0:GPRS, 1:SMS+GPRS ; 2: GPRS+SMS+CALL E.g. MOVING,ON,200,2# 2. MOVING,OFF#
14	Set center number	Set center number : CENTER,A,mobile number# Delete center number: CENTER,D#
15	Power/oil control	RELAY,A# A=0/1 0= restore petrol; 1=cut off petrol Default value : 0 E.g. RELAY,1#
16	Restart	RESET# Device restart 20 seconds after receiving this command
17	Car door negative/positive triggering setting	DOOR,A# A=0/1; 0 negative triggering, 1 positive triggering ; default: 0
18	Analog upload setting	Upload analog data: ADT,ON,T# T: upload interval; scope: 5~3600(second) Turn off analog upload: ADT,OFF# ; default: OFF
19	Find car by triggering light and buzzer	FIND#

8. Trouble shooting

If you are having trouble with your device, try these troubleshooting procedures before contacting a service professional.

Problems	Causes	Solutions
Poor signal	The signal waves unable to transmit when use the GPS tracker in the places that have poor signal reception, such as: tall building around or basement.	Using the GPS tracker in the places that have good signal condition.
Unable to boot	Low battery	Charge the device battery
Unable to connect to the network	Poor signal	Using the GPS tracker in the places that have good signal condition.
Unable to locate	Signal shielded or Poor signal	Change the installation place
No power off alarm	Built-in battery is off	Turn it on
Fail to start the car	Power cutoff / ACC abnormal	Restore power/Check ACC
Car stops driving	Abnormal power supply	Connect the device negative electrode to constant power
Offline/ Indicators off	Abnormal power supply/Indicators sleep	Check power supply/Press side key to activate indicators
No update of vehicle's location	No GPS positioning	Test the device again/ Change installation place

Warranty instructions and service

1. The warranty is valid only when the warranty card is properly completed, and upon presentation of the proof of purchase consisting of original invoice indicating the date of purchase, model and serial No. of the product. We reserve the right to refuse warranty if this information has been removed or changed after the original purchase of the product from the dealer.
2. Our obligations are limited to repair of the defect or replacement the defective part or at its discretion replacement of the product itself.
3. Warranty repairs must be carried out by our Authorized Service Centre. Warranty cover will be void, even if a repair has been attempted by any unauthorized service centre.
4. Repair or replacement under the terms of this warranty does not provide right to extension or renewal of the warranty period.
5. The warranty is not applicable to cases other than defects in material, design and workmanship.

Maintenance Record

Date		Serviced by	
Product Model			
IMEI Number			
Fault Descriptions			
Comments			